

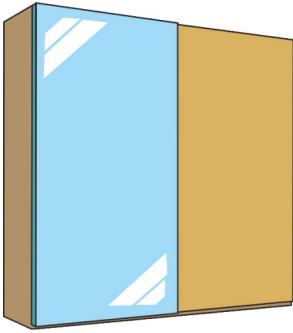

**GUIA PRÁTICO REVENDA**



### Portas Flutuantes



Sistema para portas Flutuantes, peso da porta até 50kg.

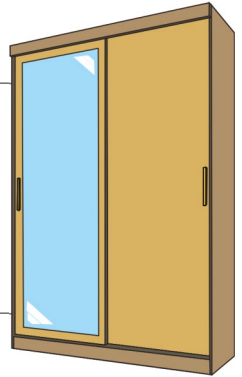

### Roupeiros



Sistema roupeiros com sustentação na base para portas de Até 60kg.

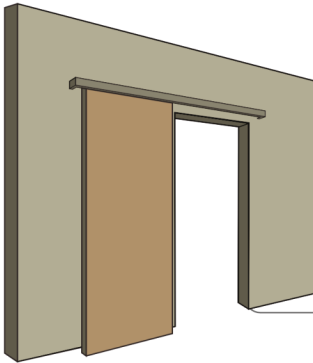

### Porta de Passagem



Sistema para portas de passagem, peso da porta até 100kg.

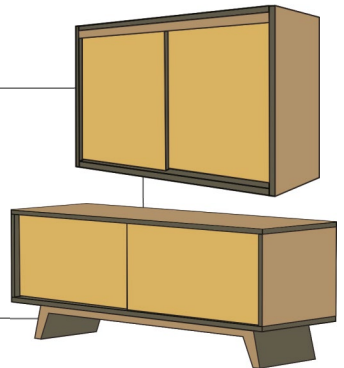

### Portas Pequenas









Sistema para portas pequenas com peso de até 35kg.

### Acessórios



Acessórios para sistema de portas de correr.

## ÍNDICE

Azure	04
Amortecedor Azure	06
JP 360	08
JP 240	09
JP 85	10
Dispositivo Anti Rebote	11
Guia Universal FZ	12
Guia Universal com Amortecimento FZ	13
Guia Fixa FZ	14
Guia Fixa Com Amortecimento FZ	15
JP 700 Soft 	16
JP 700	17
JP 700 Light 	18
JP 735 	19
JP 25	20
JP 35	21
JM 410 Duo 	22
JM 410	23
JP NANO	23
JP 55	23
JM 620 	24
JM 621 	24
JM 443	24
JM 600	24
Suporte de Tv	25
Perfís	26



PORTAS  
FLUTUANTES

# AZURE

produto patentado



-  ANTI  
DESCARRILAMENTO
-  FÁCIL  
MONTAGEM
-  MELHOR CUSTO  
BENEFÍCIO
-  RODA DE 30MM  
COM ROLAMENTO
-  MECANISMO  
BLINDADO
-  PORTA  
FLUTUANTE
-  SISTEMA  
EM AÇO
-  Kg  
SUPORTA  
50KG

Portas Flutuantes  
ao alcance do seu  
Projeto

Opcional  
Amortecedor  
**AZURE**  
Pag. 6



# KIT PARA 2 E 3 PORTAS

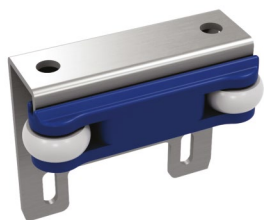

Guia Interna

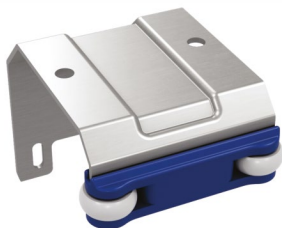

Guia Externa

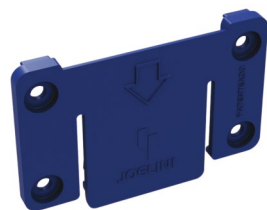

Suporte de Guia



Roldana Interna

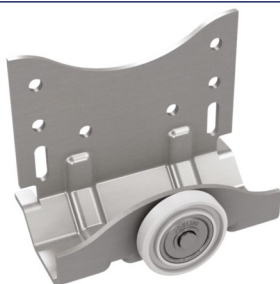

Roldana Externa

## FACILIDADE NA INSTALAÇÃO E REMOÇÃO

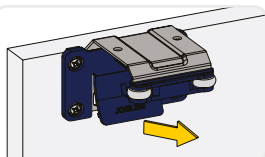

PESO DA PORTA  
APOIADO NA BASE

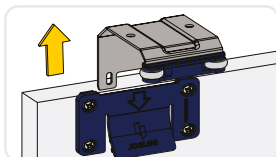

SISTEMA PARA  
2 OU 3 PORTAS

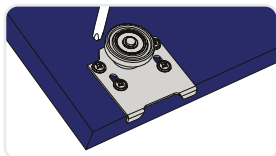

PORTA INTERNA 1

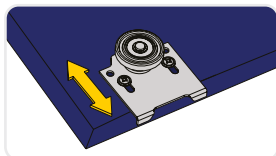

PORTA INTERNA 2

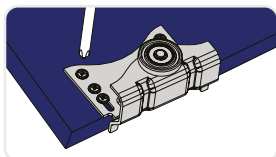

PORTA EXTERNA 1

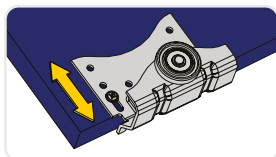

PORTA EXTERNA 2

## ESPESSURAS E MEDIDAS

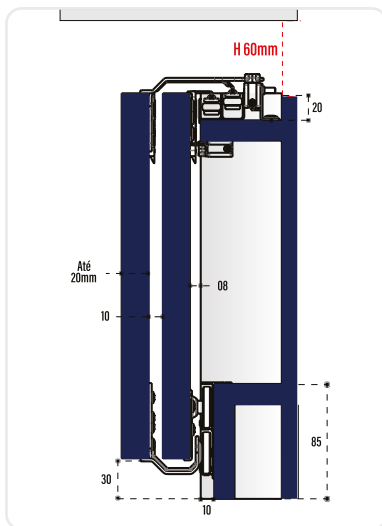



PORTAS  
FLUTUANTES

# Amortecedor AZURE

produto com patente requerida



*O UPGRADE DEFINITIVO  
PARA PORTAS FLUTUANTES*

EXPERIMENTE O KIT AMORTECEDOR PARA O SISTEMA  
AZURE E DESFRUTE DO FECHAMENTO SUAVE E SEGURO  
NAS SUAS PORTAS FLUTUANTES

## KIT PARA 2 E 3 PORTAS



**Amortecedor para  
Porta externa**



**Pescador para  
Porta externa**



**Amortecedor para  
Porta Interna**



**Pescador para  
Porta Interna**

## BENEFÍCIOS



**BASE EM AÇO  
COM ABA DE APOIO**



**SUPOORTE DE ENCAIXE NA  
PORTA EM AÇO COM ABA DE APOIO**

## ESPESSURAS E MEDIDAS

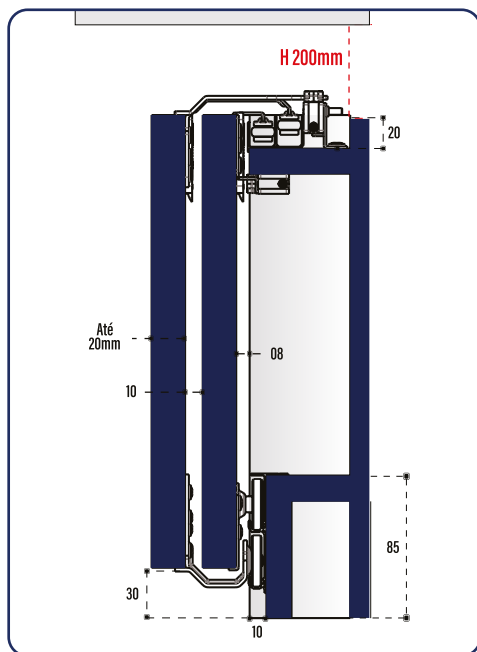



ROUPEIROS

# JP360

produto com patente requerida



MECANISMO  
BLINDADO



ANTI  
CARRILAMENTO



RODA COM  
ROLAMENTO



PARAFUSO DE  
REGULAGEM REFORÇADO



SUPORTA  
60KG



ROLDANA  
SOBREPOSTA

## OPÇÕES DE GUIA



FIXA FZ



UNIVERSAL FZ



1 RODA

## GUIA COM AMORTECIMENTO



UNIVERSAL  
FZ



FIXA FZ

Opcional

Trava de  
liberação



ANTI REBOTE  
pág. 13

Abas de  
Apoio



Corpo em  
aço

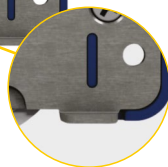

## ESPESSURAS E MEDIDAS

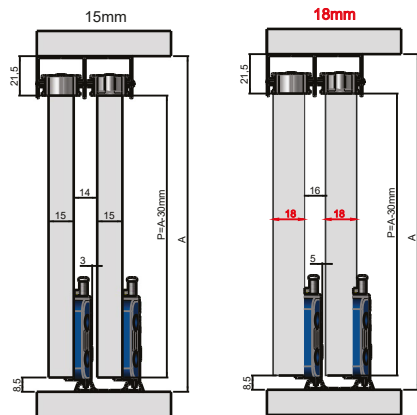
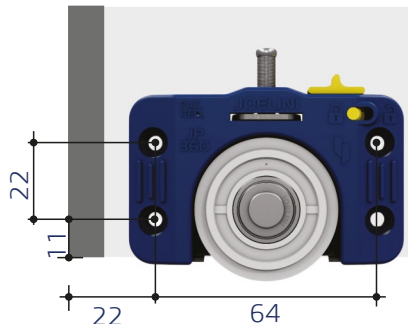





ROUPEIROS

# JP240

produto com patente requerida



MECANISMO BLINDADO



RODA COM ROLAMENTO



SUporta 50KG



ANTI DESCARRILAMENTO



PARAFUSO DE REGULAGEM REFORÇADO



ROLDANA SOBREPOSTA

## OPÇÕES DE GUIA



FIXA FZ



UNIVERSAL FZ



1 RODA

## GUIA COM AMORTECIMENTO



UNIVERSAL FZ



FIXA FZ

Opcional



ANTI REBOTE  
pág. 13

Trava de liberação

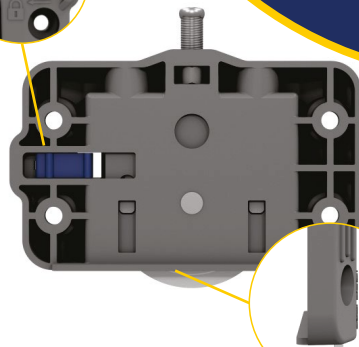

Aba de Apoio

## ESPESSURAS E MEDIDAS

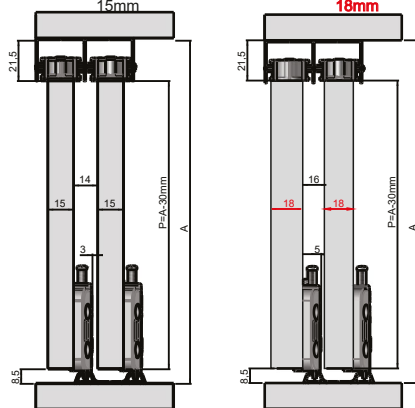
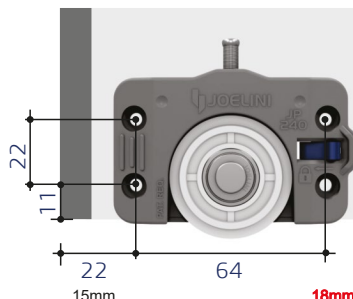



ROUPEIROS

# JP85

produto com patente requerida

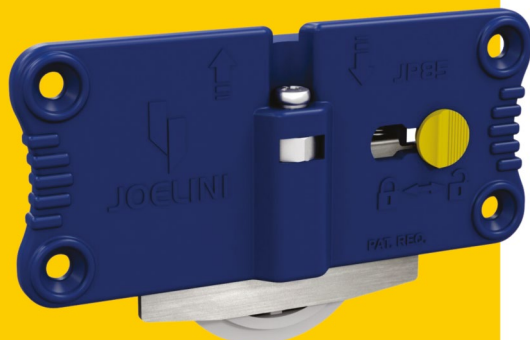

MECANISMO  
BLINDADO



RODA COM  
ROLAMENTO



SUPOORTA  
50KG



ANTI  
DESCARRILAMENTO



PARAFUSO DE  
REGULAGEM REFORÇADO



ROLDANA  
EMBUTIDA

## OPÇÕES DE GUIA



FIXA FZ



UNIVERSAL FZ



1 RODA

## GUIA COM AMORTECIMENTO



UNIVERSAL  
FZ



FIXA FZ

Opcional



ANTI REBOTE  
pág. 13

Parafuso de  
Regulagem



Trava de  
liberação



## ESPESSURAS E MEDIDAS

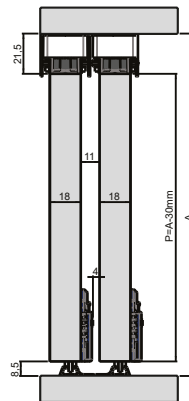
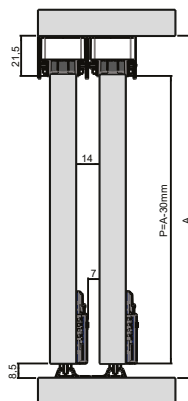



ACESSÓRIOS

# Dispositivo ANTI REBOTE

produto com patente requerida

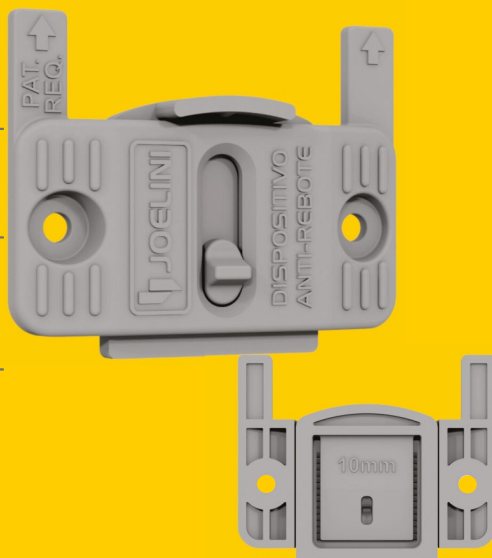

## INSTALAÇÃO E REGULAGEM SUPER FÁCIL



Botão de Regulagem



PARA PORTAS COM SUSTENTAÇÃO NA BASE



FÁCIL MONTAGEM



PORTAS DE MADEIRA E ALUMÍNIO



MELHOR CUSTO BENEFÍCIO



TRILHOS 27 A 32

## OPCIONAIS NOS KITS



JP 360



JP 240

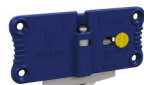

JP 85

## APLICAÇÃO

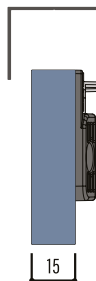

## REGULAGEM

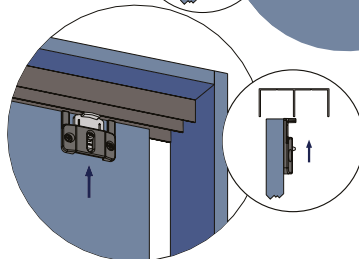
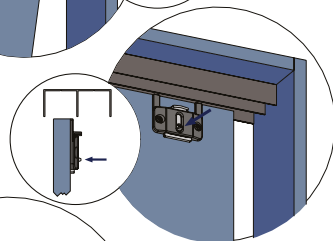
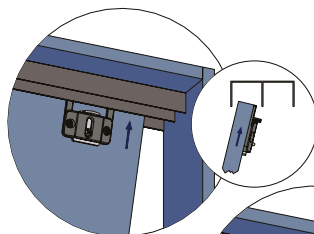



ROUPEIROS

# GUIA Z

Universal

## FOLGA ZERO

produto com patente requerida

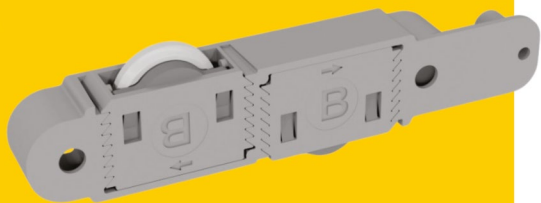
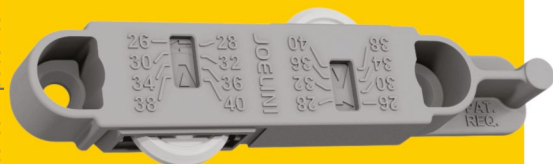

## MONTAGEM NO TOPO DA PORTA



FÁCIL MONTAGEM



DISPENSA USO DE CHAVE DE REGULAGEM



PORTAS DE MADEIRA E ALUMÍNIO



FIXAÇÃO NO TOPO



SILENCIOSO E SEGURO

## OPÇÕES DE MEDIDA

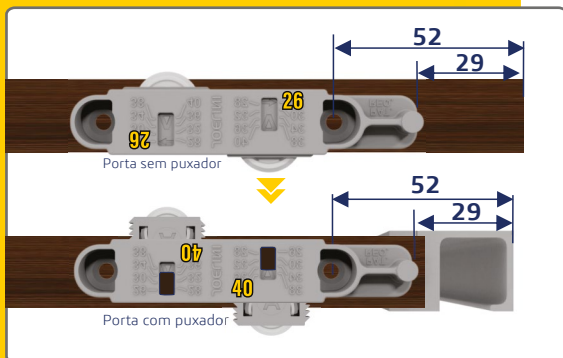

## ESPESSURAS E MEDIDAS

VISOR DE REGULAGEM



SETA DE INDICAÇÃO DA MEDIDA



MEDIDAS DOS TRILHOS

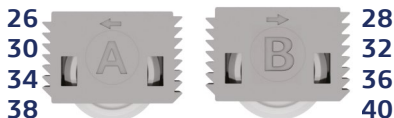

## APLICAÇÃO



VISTA SUPERIOR DA PORTA



ROUPEIROS

# GUIA Z

Universal com FOLGA ZERO Amortecimento

# SUPORTA 60KG

produto com patente requerida



## ESPESSURAS E MEDIDAS

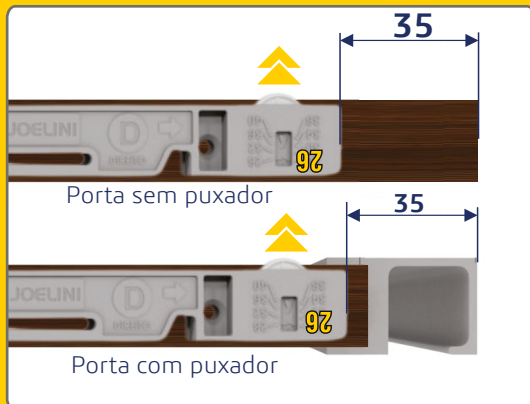

## MONTAGEM NO TOPO DA PORTA



## OPCIONAIS NOS KITS



JP 360



JP 240



JP 85

## MEDIDAS DOS TRILHOS

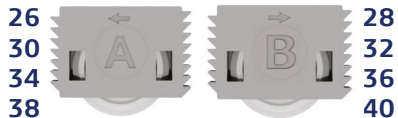

## APLICAÇÃO



VISTA SUPERIOR DA PORTA



ROUPEIROS

# GUIA Z

Fixa

FOLGA ZERO

produto com patente requerida



## ESPESSURAS E MEDIDAS

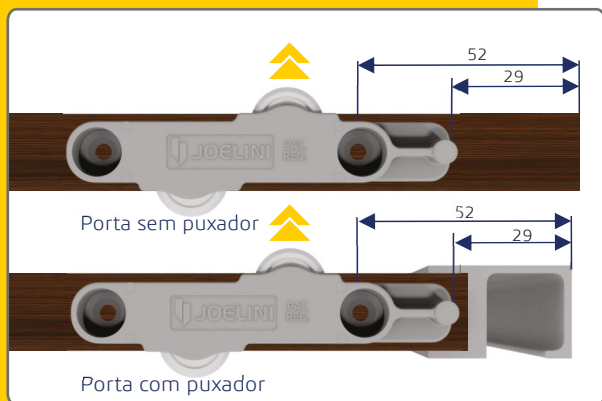

## APLICAÇÃO



VISTA SUPERIOR DA PORTA

## MONTAGEM NO TOPO DA PORTA



FÁCIL MONTAGEM



DISPENSA USO DE CHAVE DE REGULAGEM



PORTAS DE MADEIRA E ALUMÍNIO



FIXAÇÃO NO TOPO



SILENCIOSO E SEGURO



MELHOR CUSTO BENEFÍCIOS

## OPÇÕES PARA OS TRILHOS



## OPCIONAIS NOS KITS





ROUPEIROS

# GUIA Z

Fixa com Amortecimento

FOLGA ZERO

## SUPOORTA 35KG

produto com patente requerida



### ESPESSURAS E MEDIDAS

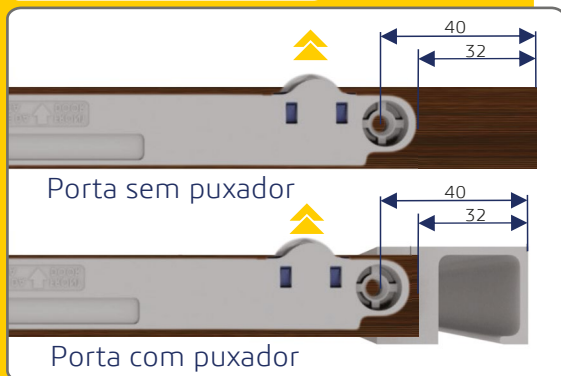

### MONTAGEM NO TOPO DA PORTA



### OPCIONAIS NOS KITS



JP 360



JP 240



JP 85

### OPÇÕES PARA OS TRILHOS



Branco

27mm

Azul

28,5mm

Verde

30mm

Amarelo

32mm

Vermelho

33,5mm

### APLICAÇÃO







PORTAS DE PASSAGEM

# JP700 SOFT



## KIT JP700 SOFT-60 DUPLO



RODA DE 25MM  
COM ROLAMENTO



PARAFUSO DE  
REGULAGEM REFORÇADO



MELHOR CUSTO  
BENEFÍCIO



PORTA DE  
PASSAGEM



SUPORTA  
40KG



CHAVE DE  
REGULAGEM

## INDICAÇÕES

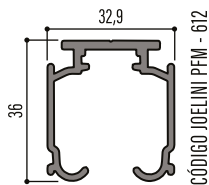

TRILHO  
RECOMENDADO



ESPESSURA MÍNIMA  
DA PORTA

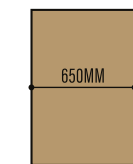

LARGURA MÍNIMA  
DA PORTA

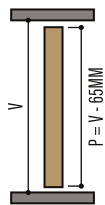

DESCONTOS

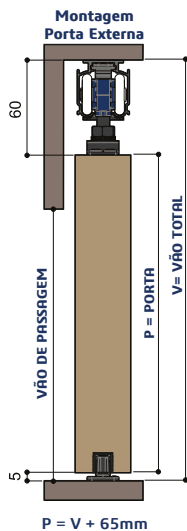
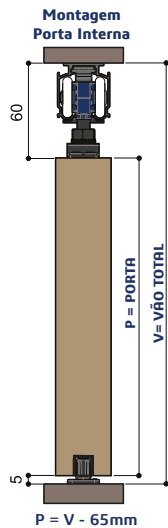





PORTAS DE PASSAGEM

# JP700

produto com patente requerida

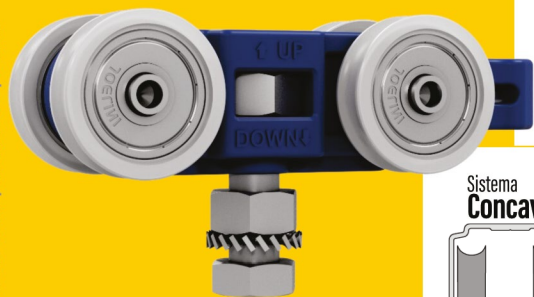

Sistema **Concavo**



Sistema **Convexo**

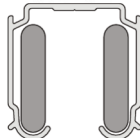

RODA DE 25MM COM ROLAMENTO



PARAFUSO DE REGULAGEM REFORÇADO



MELHOR CUSTO BENEFÍCIO



PORTA DE PASSAGEM



SUPORTA 100KG



CHAVE DE REGULAGEM

## ITENS DO KIT

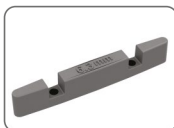

GUIA 6,3



CHAVE 13

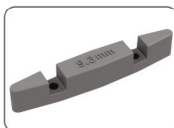

GUIA 9,3



SUPORTE DE TOPO

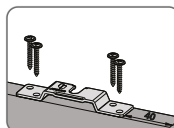

▲ OU ▼

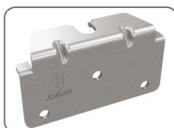

SUPORTE LATERAL

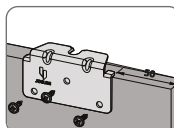

## ESPESSURAS E MEDIDAS

CÁLCULO ALTURA DE PORTA

COLOCAÇÃO DA PORTA

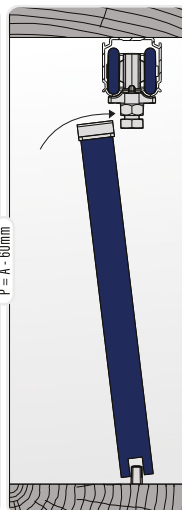
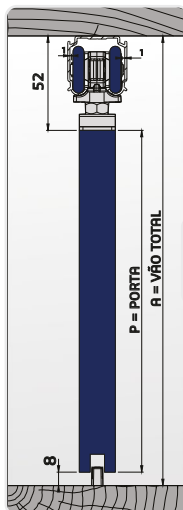



PORTAS DE PASSAGEM

# JP700 LIGHT



Sistema Convexo

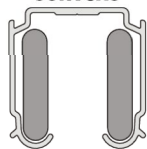

TRILHO RECOMENDADO

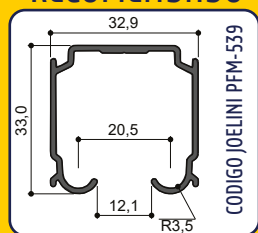

CODIGO JOELINI PFM-539

produto com patente requerida



RODA DE 25MM SEM ROLAMENTO



PARAFUSO DE REGULAGEM REFORÇADO



MELHOR CUSTO BENEFÍCIO



PORTA DE PASSAGEM



SUPORTA 35 KG



CHAVE DE REGULAGEM

## ITENS DO KIT

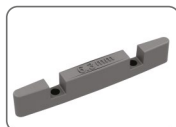

GUIA 6,3



CHAVE 13

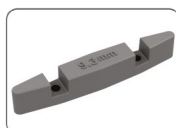

GUIA 9,3



SUPORTE DE TOPO

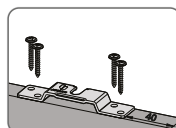

▲ OU ▼

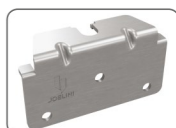

SUPORTE LATERAL

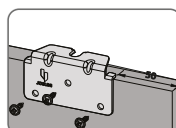

## ESPESSURAS E MEDIDAS

CÁLCULO ALTURA DE PORTA

COLOCAÇÃO DA PORTA

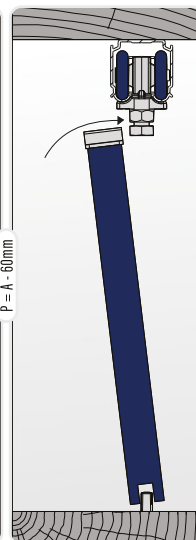
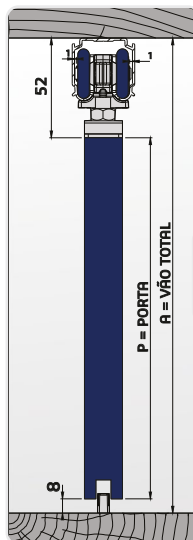



PORTAS DE PASSAGEM

# JP735

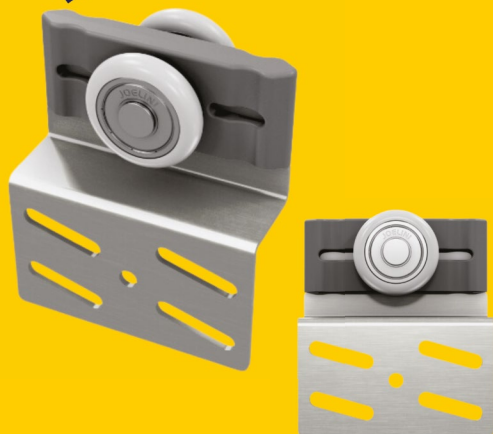

## KIT JP735

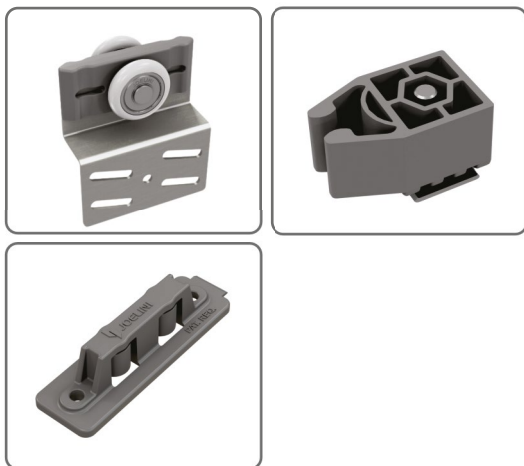

## FIXAR CARROS

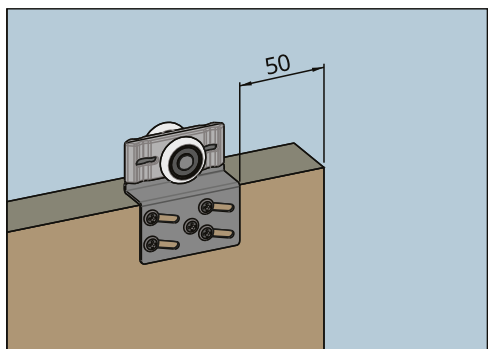

RODA DE 25MM  
COM ROLAMENTO



MELHOR CUSTO  
BENEFÍCIO



PORTA DE  
PASSAGEM



SUPOORTA  
50 KG

## INDICAÇÕES

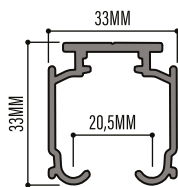

TRILHO  
RECOMENDADO

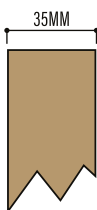

ESPESSURA  
DE PORTA



LARGURA MÍNIMA  
DE PORTA

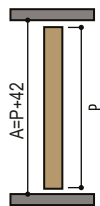

DESCORTOS  
DA PORTA



PORTAS PEQUENAS

# JP25

produto com patente requerida



MECANISMO BLINDADO



RODA COM ROLAMENTO



SUPORTA 30KG



GUIA COM MOLLA



ROLDANA SOBREPOSTA

## TRILHOS RECOMENDADOS

Embutido

ou

Sobreposto



## ESPESSURAS E MEDIDAS

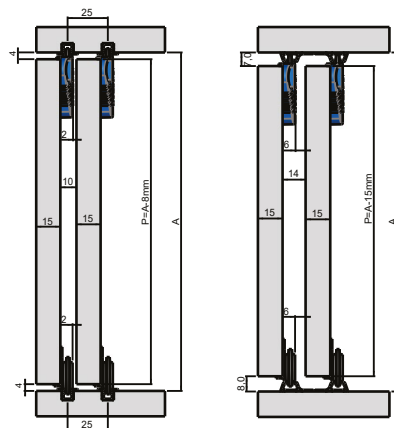



PORTAS PEQUENAS

# JP35

produto com patente requerida



APOIO PARA ENCAIXE

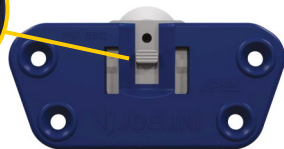

TRAVA DE LIBERAÇÃO



## USINAGEM ALOJAMENTO DO SISTEMA

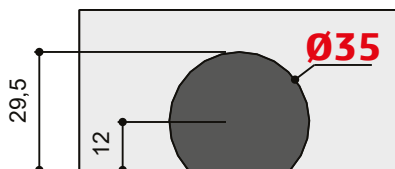

Profundidade: 12mm



MECANISMO BLINDADO



RODA COM ROLAMENTO



SUPOORTA 30KG



GUIA COM MOLA



PARAFUSO DE REGULAGEM REFORÇADO



ROLDANA EMBUTIDA

## TRILHOS RECOMENDADOS

Embutido

ou

Sobreposto



## ESPESSURAS E MEDIDAS

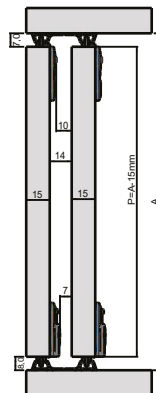



**PORTAS PEQUENAS**



# JM410

**DUO**

**ESPESSURAS E MEDIDAS**

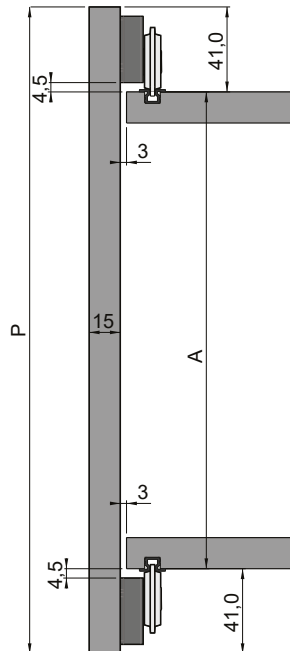

**MELHOR CUSTO BENEFÍCIO**



**SUPORTA PORTA DE ATÉ 45KG**

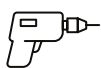

**FÁCIL MONTAGEM**



**ROLDANA SOBREPOSTA**



**PORTAS DE MADEIRA E ALUMÍNIO**



**PARA PORTAS COM SUSTENTAÇÃO NA BASE**



**RODA COM ROLAMENTO**



**PORTA FLUTUANTE**

**22**

**JOELINI**



PORTAS  
PEQUENAS

# JM410

## Roldana Deslocada



MELHOR CUSTO  
BENEFÍCIO



SUPORTA PORTA  
DE ATÉ 45KG



FÁCIL  
MONTAGEM



ROLDANA  
SOBREPOSTA



PORTAS DE MADEIRA  
E ALUMÍNIO



PARA PORTAS COM  
SUSTENTAÇÃO NA BASE



RODA COM  
ROLAMENTO



PORTA  
FLUTUANTE

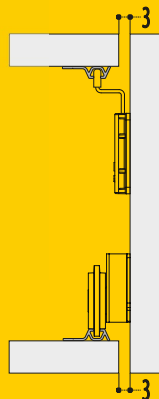

# JP55



MELHOR CUSTO  
BENEFÍCIO



SUPORTA PORTA  
DE ATÉ 10KG



FÁCIL  
MONTAGEM



ROLDANA  
EMBUÍDA



PORTAS DE MADEIRA  
E ALUMÍNIO



PARA PORTAS COM  
SUSTENTAÇÃO NA BASE



RODA DE 41MM  
COM ROLAMENTO



GUIA  
COM MOLLA

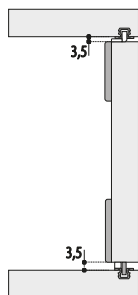

# JPNANO



MELHOR CUSTO  
BENEFÍCIO



SUPORTA PORTA  
DE ATÉ 10KG



FÁCIL  
MONTAGEM



ROLDANA  
SOBREPOSTA



PORTAS DE MADEIRA  
E ALUMÍNIO



PARA PORTAS COM  
SUSTENTAÇÃO NA BASE



RODA COM  
ROLAMENTO



GUIA  
COM MOLLA







ROUPEIROS

# JM621



MELHOR CUSTO BENEFÍCIO



SUPORTA PORTA DE ATÉ 45KG



FÁCIL MONTAGEM



ROLDANA SOBREPOSTA



PORTAS DE MADEIRA E ALUMÍNIO



PARA PORTAS COM SUSTENTAÇÃO NA BASE



RODA DE 41MM COM ROLAMENTO

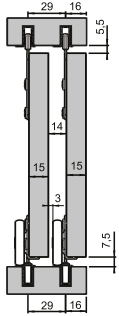
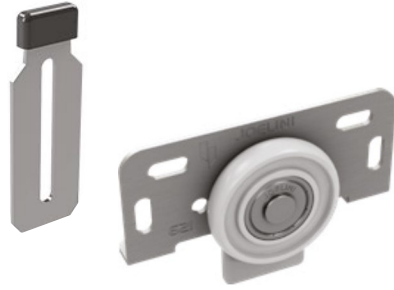

# JM620



MELHOR CUSTO BENEFÍCIO



SUPORTA PORTA DE ATÉ 45KG



FÁCIL MONTAGEM



ROLDANA EMBUTIDA



PORTAS DE MADEIRA E ALUMÍNIO



PARA PORTAS COM SUSTENTAÇÃO NA BASE



RODA DE 41MM COM ROLAMENTO

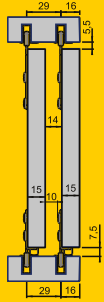
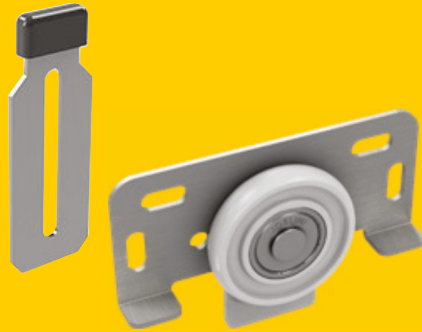

# JM600



MELHOR CUSTO BENEFÍCIO



SUPORTA PORTA DE ATÉ 45KG



FÁCIL MONTAGEM



ROLDANA EMBUTIDA/SOBREPOSTA



PORTAS DE MADEIRA E ALUMÍNIO



PARA PORTAS COM SUSTENTAÇÃO NA BASE



RODA COM ROLAMENTO

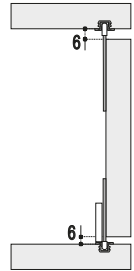

# JM443



MELHOR CUSTO BENEFÍCIO



SUPORTA PORTA DE ATÉ 45KG



FÁCIL MONTAGEM



ROLDANA SOBREPOSTA



PORTAS DE MADEIRA E ALUMÍNIO



PARA PORTAS COM SUSTENTAÇÃO NA BASE



RODA DE 41MM COM ROLAMENTO

## OPÇÕES DE GUIA



FOLGAZERO



FOLGAZERO UNIVERSAL



1 RODA

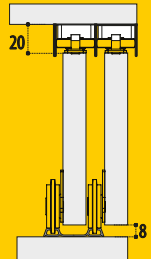



# SUPOORTE

Para Tv



## MEDIDAS



SUPORTA  
80KG



SISTEMA  
EM AÇO



ESPAÇO DE 35MM  
ENTRE TV E PAREDE



GABARITO  
DE FURAÇÃO



MELHOR CUSTO  
BENEFÍCIO

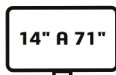

PARA TVS  
DE 14\"/>

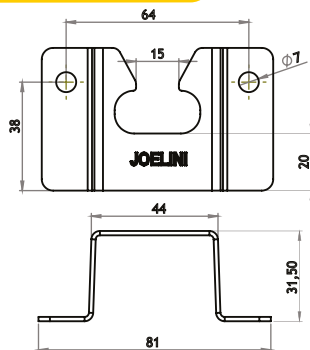

## APLICAÇÃO



1 Coloque o gabarito e faça a furação no local indicado.



2 Coloque o espaçador nas entradas da sua Tv.

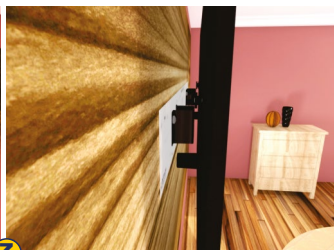

3 Fixe na Tv e a encaixe nos suportes da parede.

# PERFÍS

**PFM 539**

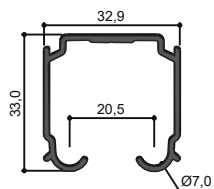

Trilho Convexo Jp700

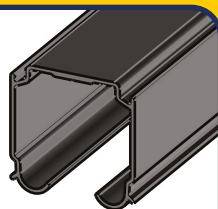

**PFM 540**

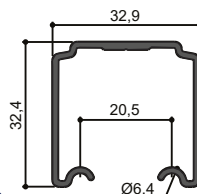

Trilho Concavo Jp700

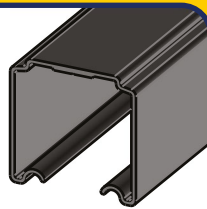

**PFM 612**

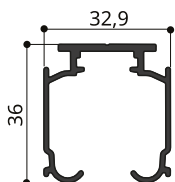

Trilho Convexo Jp700 soft

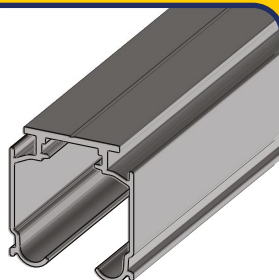

**Sanefa**

**PFM 600**

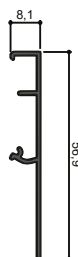

Sanefa Para Jp700

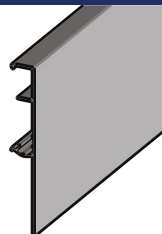

**PFM 541**

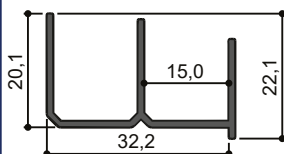

Trilho Superior Azure

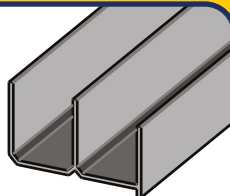

**PFM 457**

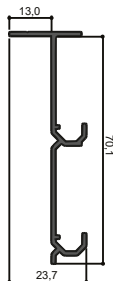

Trilho Inferior Azure

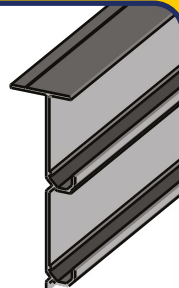

**PFM 458**

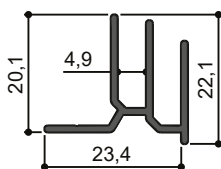

Trilho Superior Genesis

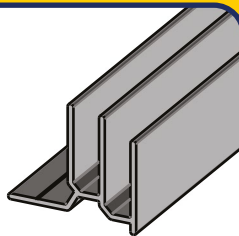

**PFM 436**

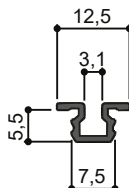

Trilho Embutido simples

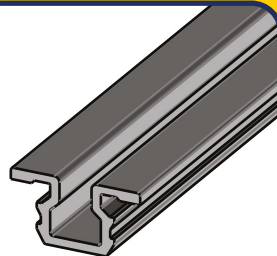

## PFM 440

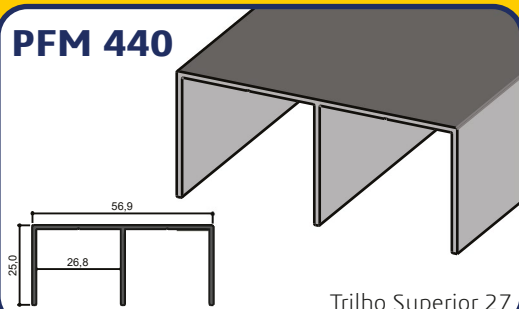

Trilho Superior 27

## PFM 441

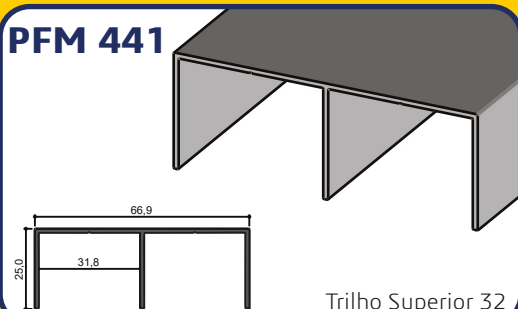

Trilho Superior 32

## PFM 601

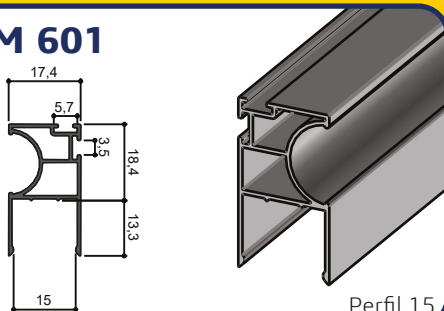

Perfil 15

## PFM 506

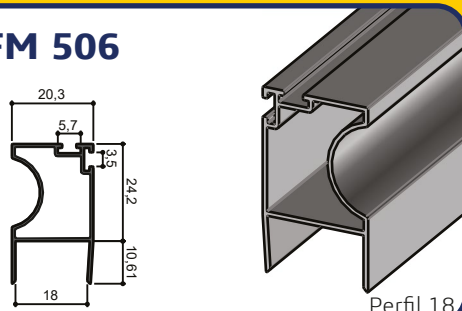

Perfil 18

## PFM 474

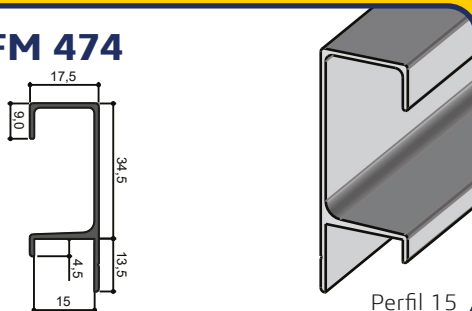

Perfil 15

## PFM 475

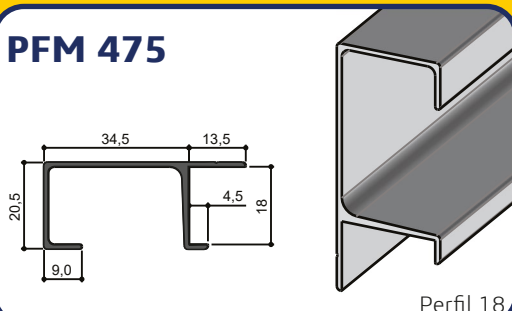

Perfil 18

## PFM 572

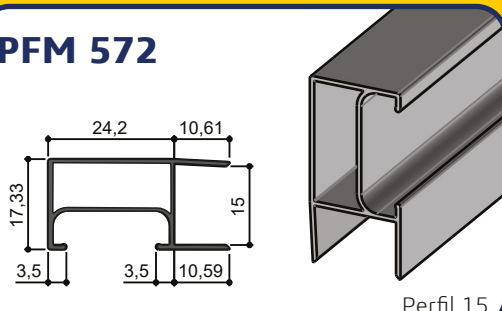

Perfil 15

## PFM 571

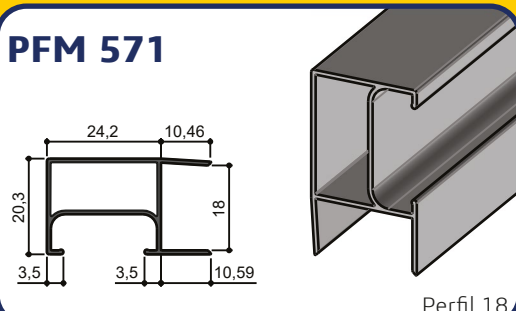

Perfil 18

### PFM 438

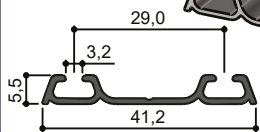

Trilho Inferior 29

### PFM 439

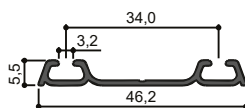

Trilho Inferior 34

### PFM 477

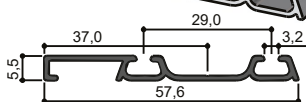

Trilho Inferior 29

### PFM 478

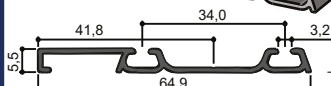

Trilho Inferior 34

### PFM 478

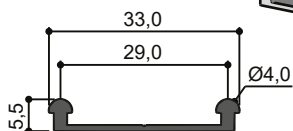

Trilho concavo 29

### PFM 504

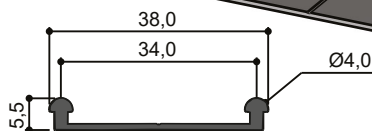

Trilho concavo 34

### PFM 437

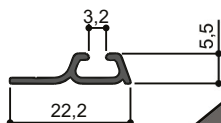

Trilho simples

### PFM 462

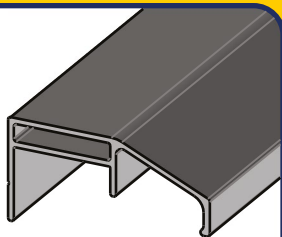
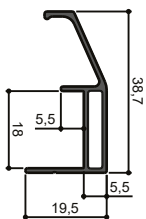

Perfil 18

### PFM 461

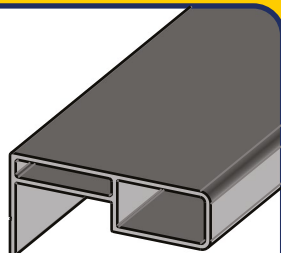
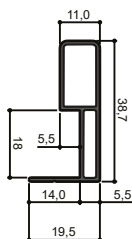

Perfil 18

### PFM 459

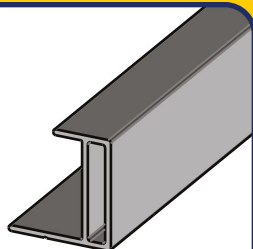
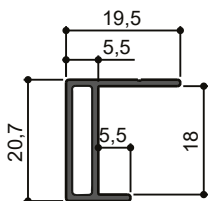

Perfil arremate 18

### PFM 476

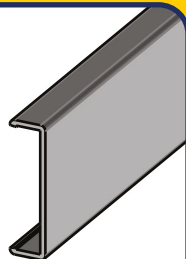
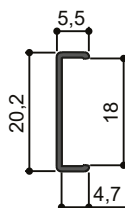

Perfil arremate 18

### PFM 473

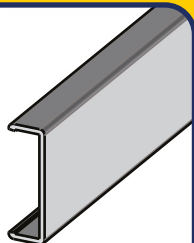
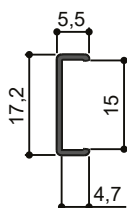

Perfil arremate 15

### PFM 599

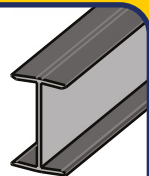
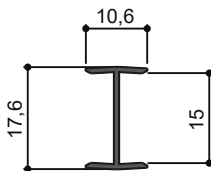

Perfil arremate H

### PFM 152

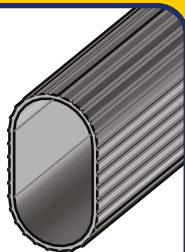
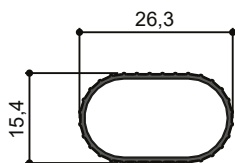

Tubo cabideiro

### PFM 589

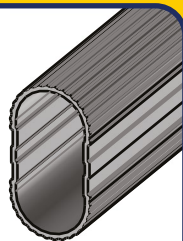
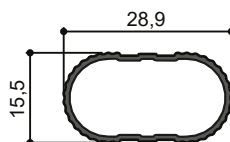

tubo cabideiro

# ANOTAÇÕES

A large white rectangular area with rounded corners, containing horizontal black lines for writing, set against a yellow background.

# ANOTAÇÕES

A large white rectangular area with rounded corners, containing horizontal black lines for writing, set against a yellow background.



[www.joelini.com.br](http://www.joelini.com.br)

+55 43 3172-4359 | [sac@joelini.com.br](mailto:sac@joelini.com.br)

[facebook.com/joeliniferragens](https://facebook.com/joeliniferragens) | [instagram.com/joelini](https://instagram.com/joelini)

R. Arapaçu-Listrado, 260, Pq. Ind. II, Arapongas - PR - CEP 86703-295

**Joelini Ind de Produtos Plasticos e Metais Ltda**